

MADE IN ITALY. MADE TO EXCEL.

LOG

SELECT

Interactive version



WOOD LOOK

PORCELAIN TILES

Gres Porcellanato
Grès cérame
Feinsteinzeug
Gres porcelánico
Керамический гранит

FABRIC LOOK

WALL TILES

Rivestimenti
Revêtements
Wandfliesen
Revestimientos
Настенная плитка



Atlas Concorde is one of the leading global brands in the production of ceramic tiles and large slabs for design and architecture. With over 50 years of history, two production plants, and numerous showroom in the capitals of international design, Atlas Concorde offers integrated and sustainable ceramic systems for floors, walls, outdoor spaces, worktops, bathroom furnishings, facades and special projects. Design your world with Atlas Concorde.

Atlas Concorde è uno dei principali brand mondiali nella produzione di superfici e grandi lastre ceramiche per il design e l'architettura. Con oltre cinquant'anni di storia, due stabilimenti produttivi, numerose showroom nelle capitali della progettazione internazionale, offriamo sistemi ceramici integrati e sostenibili per pavimenti, rivestimenti, outdoor, piani di lavoro, arredo bagno, facciate e progetti speciali. Design your world with Atlas Concorde.

atlasconcorde.com

INDEX

- ⇨ INSPIRATION
- ⇨ IMAGE GALLERY
- ⇨ SURFACE RANGE & TECHNICAL SPECIFICATIONS

INSPIRATION

IMAGE
GALLERYSURFACE
RANGE &
TECHNICAL
SPECSENJOY
THE VIDEO

INDEX



INSPIRATION



IMAGE
GALLERY



SURFACE
RANGE &
TECHNICAL
SPECS



ENJOY
THE VIDEO



SELECTED FOR DESIGN



PURE
Knot-free
and soft grain

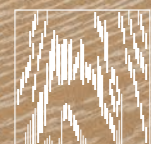

FLAMED
Decapé with
waved grain



SAWN
Refined
saw-cut effect

OAK INSPIRATION REFINED BY EXPERTS

INDEX



INSPIRATION



IMAGE
GALLERY



SURFACE
RANGE &
TECHNICAL
SPECS



ENJOY
THE VIDEO



PURE

A selection of the most refined oak grains and flames revealing the purest expression of natural elegance

FLAMED

A brushing process enhancing the oak's most expressive flames, showcasing their natural beauty through subtle tonal contrast

SAWN

A traditional saw-cut texture redefined with modern precision, giving the surface a dynamic and tactile effect

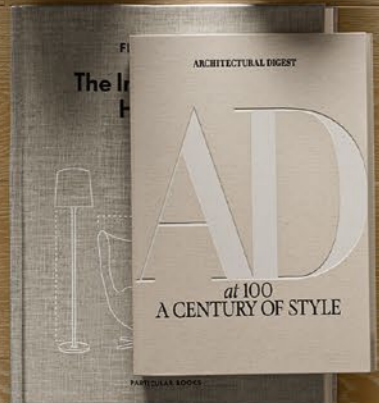



PURE

The purest oak selection
understated, refined, timeless



INDEX



INSPIRATION



IMAGE
GALLERY



SURFACE
RANGE &
TECHNICAL
SPECS



ENJOY
THE VIDEO





INDEX



INSPIRATION



IMAGE GALLERY



SURFACE RANGE & TECHNICAL SPECS



ENJOY THE VIDEO

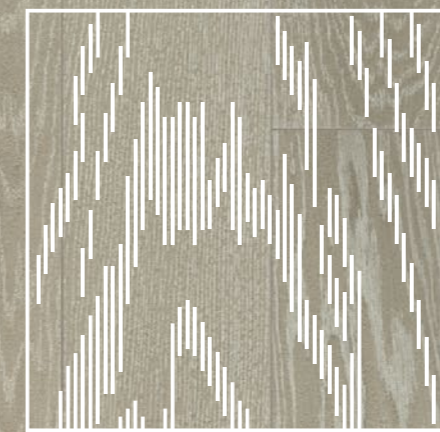

FLAMED

The elegant revival of oak's grain, reinterpreted for contemporary living



SAWN

The ancient texture of sawn wood, reimagined with modern precision



INDEX



INSPIRATION



IMAGE GALLERY



SURFACE RANGE & TECHNICAL SPECS



ENJOY THE VIDEO



atlas concorde | ITLAS

ITLAS is a premier Italian company that has been crafting natural wood flooring for over 30 years, combining design, innovation, and the quality of Made in Italy.

DESIGNED WITH THE MASTERS

INDEX



INSPIRATION



IMAGE
GALLERY



SURFACE
RANGE &
TECHNICAL
SPECS



ENJOY
THE VIDEO



VEST

THE PERFECT MATCH



FROM WOVEN
SURFACES



TO ARCHITECTURAL
FABRIC



XL DECOR
FOR BOLD INTERIORS



3D QUBE
HARMONY IN RELIEF

INDEX



INSPIRATION



IMAGE
GALLERY



SURFACE
RANGE &
TECHNICAL
SPECS



ENJOY
THE VIDEO



One Space

the Atlas Concorde ceramic ecosystem



Image Gallery

Living With Terrace
Bright Pure



Spa In&Out
Icon Pure



Home Bathroom
Amber Pure



Living With Garden
Silver Flamed



Luxury Bathroom
White Flamed



Concept Store
Icon Flamed



Restaurant
Moka Flamed



Home Kitchen
Ivory Sawn



- LIVING WITH TERRACE
- SPA IN&OUT
- HOME BATHROOM
- LIVING WITH GARDEN
- LUXURY BATHROOM
- CONCEPT STORE
- RESTAURANT
- HOME KITCHEN

INDEX



INSPIRATION



IMAGE
GALLERY



LIVING WITH TERRACE
SPA IN&OUT
HOME BATHROOM
LIVING WITH GARDEN
LUXURY BATHROOM
CONCEPT STORE
RESTAURANT
HOME KITCHEN

SURFACE
RANGE &
TECHNICAL
SPECS



ENJOY
THE VIDEO



PURE



FLOOR
Log Select
Bright Pure
 Matte Sensitech
 20x180 cm | 7⁷/₈"x70⁷/₈"

WALL
Vest
Cotton
 Matte
 120x278 cm | 47¹/₄"x109¹/₂"

FURNITURE
Atlas Plan
Calacatta Viola
 Polished
 162x324 cm | 63³/₄"x127¹/₂"

SIDE TABLE | **TRATTO - GIOTTO**
Atlas Concorde Habitat
Nero Marquina
 Silk - Polished
 ø 45 cm | 17³/₄" - ø 65 cm | 25⁵/₈"

SIDE TABLE | **TRATTO - GIOTTO**
Atlas Concorde Habitat
Fior di Bosco
 Silk - Polished
 ø 120 cm | 47¹/₄"

INDEX



INSPIRATION



IMAGE GALLERY



LIVING WITH TERRACE
 SPA IN&OUT
 HOME BATHROOM
 LIVING WITH GARDEN
 LUXURY BATHROOM
 CONCEPT STORE
 RESTAURANT
 HOME KITCHEN

SURFACE RANGE & TECHNICAL SPECS



ENJOY THE VIDEO





FLOOR
Log Select
Bright Pure
 Matte Sensitech
 20x180 cm | 7⁷/₈"x70⁷/₈"

WALL
Vest
Cotton
 Matte
 120x278 cm | 47¹/₄"x109¹/₂"

SIDE TABLE | **TRATTO - GIOTTO**
Atlas Concorde Habitat
Nero Marquina
 Silk - Polished
 ø 45 cm | 17³/₄" - ø 65 cm | 25⁵/₈"

SIDE TABLE | **TRATTO - GIOTTO**
Atlas Concorde Habitat
Fior di Bosco
 Silk - Polished
 ø 120 cm | 47¹/₄"

TRAY | **TRATTO - QUADRO**
Atlas Concorde Habitat
Nero Marquina
 Polished - Silk
 36x36 | 14¹/₈"x14¹/₈"



INDEX



INSPIRATION



IMAGE
 GALLERY



LIVING WITH TERRACE
 SPA IN&OUT
 HOME BATHROOM
 LIVING WITH GARDEN
 LUXURY BATHROOM
 CONCEPT STORE
 RESTAURANT
 HOME KITCHEN

SURFACE
 RANGE &
 TECHNICAL
 SPECS



ENJOY
 THE VIDEO





FLOOR

Log Select

Bright Pure

Matte Sensitech

20x180 cm | 7⁷/₈"x70⁷/₈"

WALL

Vest

Cotton

Matte

120x278 cm | 47¹/₄"x109¹/₂"

FURNITURE

Atlas Plan

Calacatta Viola

Polished

162x324 cm | 63³/₄"x127¹/₂"

OUTDOOR FLOOR

Log Select

Bright Pure

Grip Sensitech

20x120 cm | 7⁷/₈"x47¹/₄"

SIDE TABLE | **TRATTO - GIOTTO**

Atlas Concorde Habitat

Fior di Bosco

Silk - Polished

ø 120 cm | 47¹/₄"

INDEX



INSPIRATION



IMAGE GALLERY



LIVING WITH TERRACE
 SPA IN&OUT
 HOME BATHROOM
 LIVING WITH GARDEN
 LUXURY BATHROOM
 CONCEPT STORE
 RESTAURANT
 HOME KITCHEN

SURFACE RANGE & TECHNICAL SPECS



ENJOY THE VIDEO





OUTDOOR FLOOR
Log Select
Bright Pure
 Grip Sensitech
 20x120 cm | 7⁷/₈"x47¹/₄"

SIDE TABLE | **TRATTO - GIOTTO**
 Atlas Concorde Habitat
Fior di Bosco
 Silk - Polished
 ø 65 cm | 25⁵/₈" - ø 120 cm | 47¹/₄"

TRAY | **TRATTO - DISCO**
 Atlas Concorde Habitat
Boost Icor Bone - Dune
 Hammered
 ø 25 cm | 9⁷/₈"

INDEX



INSPIRATION



IMAGE GALLERY



- LIVING WITH TERRACE
- SPA IN&OUT
- HOME BATHROOM
- LIVING WITH GARDEN
- LUXURY BATHROOM
- CONCEPT STORE
- RESTAURANT
- HOME KITCHEN

SURFACE RANGE & TECHNICAL SPECS



ENJOY THE VIDEO





FLOOR
Log Select
Icon Pure
Matte Sensitech
18,5x150 cm | 7¹/₄"x59"

WALL
Log Select
Icon Sawn
Matte Sensitech
20x120 cm | 7⁷/₈"x47¹/₄"

Atlas Plan
Ambrosia
Hammered
160x320 cm | 63"x126"

Vest
Linen
Matte
120x278 cm | 47¹/₄"x109¹/₂"

CONSOLLE | TRATTO - ELLE
Atlas Concorde Habitat
Precious Brown
Silk
90x30x77,5 cm | 35³/₈"x11³/₄"x30¹/₂"

SINGLE SINK | ESSENZA - MONO
Atlas Concorde Habitat
Precious Brown
Silk
120x50x15 cm | 47¹/₄"x19⁵/₈"x5⁷/₈"

INDEX



INSPIRATION



IMAGE GALLERY



LIVING WITH TERRACE
SPA IN&OUT

HOME BATHROOM
LIVING WITH GARDEN
LUXURY BATHROOM
CONCEPT STORE
RESTAURANT
HOME KITCHEN

SURFACE RANGE & TECHNICAL SPECS



ENJOY THE VIDEO





WALL
Log Select
Icon Sawn
 Matte Sensitech
 20x120 cm | 7⁷/₈"x47¹/₄"

FLOOR
Log Select
Icon Pure
 Matte Sensitech
 18,5x150 cm | 7¹/₄"x59"

OUTDOOR FLOOR
Log Select
Icon Flamed
 Outdoor Sensitech ± 20mm
 30x120 cm | 11³/₄"x47¹/₄"

INDEX



INSPIRATION



IMAGE GALLERY



LIVING WITH TERRACE
SPA IN&OUT

HOME BATHROOM
LIVING WITH GARDEN
LUXURY BATHROOM
CONCEPT STORE
RESTAURANT
HOME KITCHEN

SURFACE RANGE & TECHNICAL SPECS



ENJOY THE VIDEO





FLOOR
Log Select
Icon Pure
 Matte Sensitech
 18,5x150 cm | 7¹/₄"x59"

WALL
Vest
Breath
 Matte
 120x278 cm | 47¹/₄"x109¹/₂"

Vest
Linen
 Matte
 120x278 cm | 47¹/₄"x109¹/₂"

Atlas Plan
Ambrosia
 Hammered
 160x320 cm | 63"x126"

SINGLE SINK | **ESSENZA - MONO**
Atlas Concorde Habitat
Precious Brown
 Silk
 120x50x15 cm | 47¹/₄"x19⁵/₈"x5⁷/₈"

CONSOLLE | **TRATTO - ELLE**
Atlas Concorde Habitat
Precious Brown
 Silk
 90x30x77,5 cm | 35³/₈"x11¹/₄"x30¹/₂"

WALL SHELVES | **TRATTO - OMEGA**
Atlas Concorde Habitat
Precious Brown
 Silk
 10x12x90 cm | 3⁷/₈"x4³/₄"x35³/₈"

INDEX



INSPIRATION



IMAGE GALLERY



LIVING WITH TERRACE
 SPA IN&OUT

HOME BATHROOM
 LIVING WITH GARDEN
 LUXURY BATHROOM
 CONCEPT STORE
 RESTAURANT
 HOME KITCHEN

SURFACE RANGE & TECHNICAL SPECS



ENJOY THE VIDEO



OUTDOOR FLOOR

Log Select

Icon Flamed

Outdoor Sensitech \pm 20mm
30x120 cm | 11³/₄"x47¹/₄"

OUTDOOR WALL

Log Select

Icon Flamed

Matte Sensitech
20x120 cm | 7⁷/₈"x47¹/₄"

Atlas Plan

Ambrosia

Hammered
160x320 cm | 63"x126"

SIDE TABLE | TRATTO - GIOTTO

Atlas Concorde Habitat

Boost Icor Dune - Boost Icor Bone

Hammered
ø 120 cm | 47¹/₄"

INDOOR WALL

Vest

Cotton

Matte
50x120 cm | 19⁵/₈"x47¹/₄"

TWIN SINK | DIALOGO - DUO

Atlas Concorde Habitat

Marvel T Navona White

Matte
190x45x17,5 cm | 74³/₄"x17³/₄"x6⁷/₈"

SHELF | ESSENZA - THIN

Marvel T Atlas Concorde Habitat

Navona White

Matte
190x35x5 cm | 74³/₄"x13³/₄"x2"

STORAGE UNITS | TRATTO - TORRE SLIM

Atlas Concorde Habitat

Marvel T Navona White

Matte
30x30x60 cm | 11³/₄"x11³/₄"x23⁵/₈"



INDEX



INSPIRATION



IMAGE GALLERY



LIVING WITH TERRACE
SPA IN&OUT

HOME BATHROOM
LIVING WITH GARDEN
LUXURY BATHROOM
CONCEPT STORE
RESTAURANT
HOME KITCHEN

SURFACE RANGE & TECHNICAL SPECS



ENJOY THE VIDEO





OUTDOOR FLOOR
Log Select
Icon Flamed
 Outdoor Sensitech \pm 20mm
 30x120 cm | 11³/₄"x47¹/₄"

SIDE TABLE | **TRATTO - GIOTTO**
Atlas Concorde Habitat
Boost Icor Dune - Boost Icor Bone
 Hammered
 ø 45 cm | 17³/₄" - ø 65 cm | 25⁵/₈" - ø 120 cm | 47¹/₄"



INDEX



INSPIRATION



IMAGE GALLERY



LIVING WITH TERRACE
SPA IN&OUT

HOME BATHROOM
LIVING WITH GARDEN
LUXURY BATHROOM
CONCEPT STORE
RESTAURANT
HOME KITCHEN

SURFACE RANGE & TECHNICAL SPECS



ENJOY THE VIDEO





FLOOR
Log Select
Amber Pure
Matte Sensitech
20x120 cm | 7⁷/₈"x47¹/₄"

WALL
Vest
Cotton
Matte
50x120 cm | 19⁵/₈"x47¹/₄"

Vest
3D Qube White
Matte
50x120 cm | 19⁵/₈"x47¹/₄"

TOP | ESSENZA - MONO
Atlas Concorde Habitat
Marvel T Navona White
Matte
180x45x12 cm | 70⁷/₈"x17³/₄"x4³/₄"

VANITY UNIT | ARMONIA
Atlas Concorde Habitat
Marvel T Navona White
Matte
90x45x50 cm | 35³/₈"x17³/₄"x19⁵/₈"

STORAGE UNITS | TRATTO - TORRE SLIM
Atlas Concorde Habitat
Marvel T Navona White
Matte
30x30x60 cm | 11³/₄"x11³/₄"x23⁵/₈"

WALL SHELVES | TRATTO - OMEGA
Atlas Concorde Habitat
Marvel T Navona White
Matte
10x12x60 cm | 3⁷/₈"x4³/₄"x23⁵/₈"

INDEX



INSPIRATION



IMAGE GALLERY



LIVING WITH TERRACE
SPA IN&OUT
HOME BATHROOM
LIVING WITH GARDEN
LUXURY BATHROOM
CONCEPT STORE
RESTAURANT
HOME KITCHEN

SURFACE RANGE & TECHNICAL SPECS



ENJOY THE VIDEO





FLOOR
Log Select
Amber Pure
 Matte Sensitech
 20x120 cm | 7⁷/₈"x47¹/₄"

WALL
Vest
Cotton
 Matte
 50x120 cm | 19⁵/₈"x47¹/₄"

Vest
3D Qube White
 Matte
 50x120 cm | 19⁵/₈"x47¹/₄"

TOP | **ESSENZA - MONO**
Atlas Concorde Habitat
Marvel T Navona White
 Matte
 180x45x12 cm | 70⁷/₈"x17³/₄"x4³/₄"

VANITY UNIT | **ARMONIA**
Atlas Concorde Habitat
Marvel T Navona White
 Matte
 90x45x50 cm | 35³/₈"x17³/₄"x19⁵/₈"

STORAGE UNITS | **TRATTO - TORRE SLIM**
Atlas Concorde Habitat
Marvel T Navona White
 Matte
 30x30x60 cm | 11¹/₄"x11³/₄"x23⁵/₈"

WALL SHELVES | **TRATTO - OMEGA**
Atlas Concorde Habitat
Marvel T Navona White
 Matte
 10x12x60 cm | 3⁷/₈"x4³/₄"x23⁵/₈"

INDEX



INSPIRATION



IMAGE GALLERY



LIVING WITH TERRACE
 SPA IN&OUT
 HOME BATHROOM
 LIVING WITH GARDEN
 LUXURY BATHROOM
 CONCEPT STORE
 RESTAURANT
 HOME KITCHEN

SURFACE RANGE & TECHNICAL SPECS



ENJOY THE VIDEO



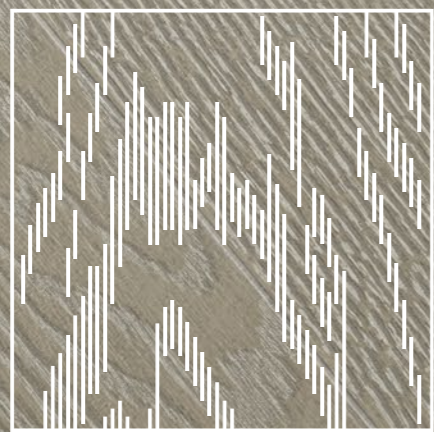

FLAMED

INDEX



INSPIRATION



IMAGE
GALLERY



LIVING WITH TERRACE
SPA IN&OUT
HOME BATHROOM
LIVING WITH GARDEN
LUXURY BATHROOM
CONCEPT STORE
RESTAURANT
HOME KITCHEN

SURFACE
RANGE &
TECHNICAL
SPECS



ENJOY
THE VIDEO





FLOOR
Log Select
 Silver Flamed
 Matte Sensitech
 20x120 cm | 7⁷/₈"x47¹/₄"

WALL
 Vest
 Cotton
 Matte
 120x278 cm | 47¹/₄"x109¹/₂"

OUTDOOR FLOOR
Log Select
 Silver Flamed
 Outdoor Sensitech \pm 20mm
 30x120 cm | 11³/₄"x47¹/₄"

STORAGE UNITS | **TRATTO - TORRE**
 Atlas Concorde Habitat
 Precious Brown
 Silk
 30x30x30-60 cm | 11³/₄"x11³/₄"xx11³/₄" - 23⁵/₈"

WALL SHELVES | **TRATTO - OMEGA**
 Atlas Concorde Habitat
 Fior di Bosco
 Silk
 10x12x60 cm | 3⁷/₈"x4³/₄"x23⁵/₈"

INDEX



INSPIRATION



IMAGE GALLERY



- LIVING WITH TERRACE
- SPA IN&OUT
- HOME BATHROOM
- LIVING WITH GARDEN
- LUXURY BATHROOM
- CONCEPT STORE
- RESTAURANT
- HOME KITCHEN

SURFACE RANGE & TECHNICAL SPECS



ENJOY THE VIDEO





FLOOR
Log Select
Silver Flamed
 Matte Sensitech
 20x120 cm | 7⁷/₈"x47¹/₄"

WALL
Vest
Cotton
 Matte
 120x278 cm | 47¹/₄"x109¹/₂"

<
 DINING TABLE | **INCONTRO 75**
Atlas Concorde Habitat
Boost Icor Dune
 Hammered
 100x240 cm | 39³/₈"x94¹/₂"

TRAY | **TRATTO - QUADRO | DISCO**
Atlas Concorde Habitat
Nero Marquina
 Polished - Silk
 25x25 - ø 25 cm | 9⁷/₈"x9⁷/₈" - ø 9⁷/₈"

^
 WALL SHELVES | **TRATTO - OMEGA**
Atlas Concorde Habitat
Precious Brown
 Silk
 10x12x60 cm | 3⁷/₈"x4³/₄"x23⁵/₈"

INDEX



INSPIRATION



IMAGE GALLERY



LIVING WITH TERRACE
 SPA IN&OUT
 HOME BATHROOM
 LIVING WITH GARDEN
 LUXURY BATHROOM
 CONCEPT STORE
 RESTAURANT
 HOME KITCHEN

SURFACE RANGE & TECHNICAL SPECS



ENJOY THE VIDEO





OUTDOOR FLOOR
Log Select
 Silver Flamed
 Outdoor Sensitech \times 20mm
 30x120 cm | 11 $\frac{3}{4}$ "x47 $\frac{1}{4}$ "

WALL
Log Select
 Silver Flamed
 Matte Sensitech
 20x120 cm | 7 $\frac{7}{8}$ "x47 $\frac{1}{4}$ "

Vest
 Cotton
 Matte
 120x278 cm | 47 $\frac{1}{4}$ "x109 $\frac{1}{2}$ "

DINING TABLE | **BROOKLYN 75**
 Atlas Concorde Habitat
 Nero Maquina
 Polished
 100x240 cm | 39 $\frac{3}{8}$ "x94 $\frac{1}{2}$ "

SIDE TABLE | **TRATTO - GIOTTO**
 Atlas Concorde Habitat
 Nero Maquina
 Polished - Silk
 \varnothing 45 cm | 17 $\frac{3}{4}$ " - \varnothing 65 cm | 25 $\frac{5}{8}$ "

INDEX



INSPIRATION



IMAGE GALLERY



LIVING WITH TERRACE
 SPA IN&OUT
 HOME BATHROOM
 LIVING WITH GARDEN
 LUXURY BATHROOM
 CONCEPT STORE
 RESTAURANT
 HOME KITCHEN

SURFACE RANGE & TECHNICAL SPECS



ENJOY THE VIDEO





OUTDOOR FLOOR
Log Select
Silver Flamed
 Outdoor Sensitech 20mm
 30x120 cm | 11³/₄"x47¹/₄"

WALL
Log Select
Silver Flamed
 Matte Sensitech
 20x120 cm | 7⁷/₈"x47¹/₄"

Vest
Cotton
 Matte
 120x278 cm | 47¹/₄"x109¹/₂"

^
SIDE TABLE | TRATTO - GIOTTO
Atlas Concorde Habitat
Nero Maquina
 Polished - Silk
 ø 45-65 cm | 17³/₄" - 25⁵/₈"

>
DINING TABLE | BROOKLYN 75
Atlas Concorde Habitat
Nero Maquina
 Polished
 100x240 cm | 39³/₈"x94¹/₂"



INDEX ≡

INSPIRATION >

IMAGE GALLERY >

- LIVING WITH TERRACE
- SPA IN&OUT
- HOME BATHROOM
- LIVING WITH GARDEN
- LUXURY BATHROOM
- CONCEPT STORE
- RESTAURANT
- HOME KITCHEN

SURFACE RANGE & TECHNICAL SPECS >

ENJOY THE VIDEO ▶



FLOOR
Log Select
 White Flamed
 Matte Sensitech
 20x120 cm | 7⁷/₈"x47¹/₄"

WALL
Vest
 Cotton
 Matte
 50x120 cm | 19⁵/₈"x47¹/₄"

Vest
 3D Qube Glam
 Matte
 50x120 cm | 19⁵/₈"x47¹/₄"

SIDE TABLE | **TRATTO - GIOTTO**
 Atlas Concorde Habitat
 Nero Marquina
 Polished - Silk
 ø 45 cm | 17³/₄"

VANITY UNIT | **DIALOGO - DUO**
 Atlas Concorde Habitat
 Marvel T Romano Silver
 Matte
 180x45x17,5 cm | 70⁷/₈"x17³/₈"x6⁷/₈"

VANITY UNIT | **ARMONIA**
 Atlas Concorde Habitat
 Marvel T Romano Silver
 Matte
 90x45x32 cm | 35³/₈"x17³/₄"x17⁷/₈"

SHELF | **ESSENZA - THIN**
 Atlas Concorde Habitat
 Marvel T Romano Silver
 Matte
 120x35x3 cm | 70⁷/₈"x13³/₄"x1¹/₈"

STORAGE UNITS | **TRATTO - TORRE SLIM**
 Atlas Concorde Habitat
 Marvel T Romano Silver
 Matte
 30x30x60 cm | 11³/₄"x11³/₄"x23⁵/₈"

WALL SHELVES | **TRATTO - OMEGA**
 Atlas Concorde Habitat
 Marvel T Romano Silver
 Matte
 10x12x60 cm | 3⁷/₈"x4³/₄"x23⁵/₈"

INDEX



INSPIRATION



IMAGE GALLERY



LIVING WITH TERRACE
 SPA IN&OUT
 HOME BATHROOM
 LIVING WITH GARDEN
 LUXURY BATHROOM
 CONCEPT STORE
 RESTAURANT
 HOME KITCHEN

SURFACE RANGE & TECHNICAL SPECS



ENJOY THE VIDEO





FLOOR
Log Select
White Flamed
 Matte Sensitech
 20x120 cm | 7⁵/₈"x47¹/₄"

<
 SIDE TABLE | **TRATTO - GIOTTO**
Atlas Concorde Habitat
Nero Marquina
 Polished - Silk
 ø 45 cm | 17³/₄"

<
 VANITY UNIT | **DIALOGO - DUO**
Atlas Concorde Habitat
Marvel T Romano Silver
 Matte
 180x45x17,5 cm | 70⁷/₈"x17⁷/₈"x6⁷/₈"

WALL
Vest
Cotton
 Matte
 50x120 cm | 19⁵/₈"x47¹/₄"

Vest
3D Qube Glam
 Matte
 50x120 cm | 19⁵/₈"x47¹/₄"

^
 WALL SHELVES | **TRATTO - OMEGA**
Atlas Concorde Habitat
Marvel T Romano Silver
 Matte
 10x12x60 cm | 3⁷/₈"x4³/₄"x23⁵/₈"

VANITY UNIT | **ARMONIA**
Atlas Concorde Habitat
Marvel T Romano Silver
 Matte
 90x45x32 cm | 35³/₈"x17³/₄"x17⁷/₈"

SHELF | **ESSENZA - THIN**
Atlas Concorde Habitat
Marvel T Romano Silver
 Matte
 120x35x3 cm | 70⁷/₈"x13³/₄"x1¹/₈"

STORAGE UNITS | **TRATTO - TORRE SLIM**
Atlas Concorde Habitat
Marvel T Romano Silver
 Matte
 30x30x60 cm | 11³/₄"x11³/₄"x23⁵/₈"

INDEX



INSPIRATION



IMAGE GALLERY



LIVING WITH TERRACE
 SPA IN&OUT
 HOME BATHROOM
 LIVING WITH GARDEN
 LUXURY BATHROOM
 CONCEPT STORE
 RESTAURANT
 HOME KITCHEN

SURFACE RANGE & TECHNICAL SPECS



ENJOY THE VIDEO





FLOOR
Log Select
Icon Flamed
 Matte Sensitech
 20x120 cm | 7⁷/₈"x47¹/₄"

WALL
Log Select
Icon Flamed
 Matte Sensitech
 20x120 cm | 7⁷/₈"x47¹/₄"

Vest
3D Qube Glam
 Matte
 50x120 cm | 19⁵/₈"x47¹/₄"

FURNITURE
Marvel T
Navona Sand
 Matte
 120x278 cm | 47¹/₄"x109¹/₂"

STORAGE UNITS | **TRATTO - TORRE**
 Atlas Concorde Habitat
 Precious Brown
 Silk
 30-90x30x30 cm | 11³/₄" - 35³/₈"x11³/₄"x11³/₄"

INDEX



INSPIRATION



IMAGE GALLERY



LIVING WITH TERRACE
 SPA IN&OUT
 HOME BATHROOM
 LIVING WITH GARDEN
 LUXURY BATHROOM
CONCEPT STORE
 RESTAURANT
 HOME KITCHEN

SURFACE RANGE & TECHNICAL SPECS



ENJOY THE VIDEO





FLOOR | WALL
Log Select
Icon Flamed
 Matte Sensitech
 20x120 cm | 7⁷/₈"x47¹/₄"

WALL
Vest
3D Qube Glam
 Matte
 50x120 cm | 19⁵/₈"x47¹/₄"

FURNITURE
Marvel T
Navona Sand
 Matte
 120x278 cm | 47¹/₄"x109¹/₂"

STORAGE UNITS | **TRATTO - TORRE**
Atlas Concorde Habitat
Precious Brown
 Silk
 30-90x30x30 cm | 11³/₄"- 35³/₈"x11³/₄"xx11³/₄"



INDEX



INSPIRATION



IMAGE
GALLERY



LIVING WITH TERRACE
 SPA IN&OUT
 HOME BATHROOM
 LIVING WITH GARDEN
 LUXURY BATHROOM
 CONCEPT STORE
 RESTAURANT
 HOME KITCHEN

SURFACE
RANGE &
TECHNICAL
SPECS



ENJOY
THE VIDEO





FLOOR
Log Select
 Moka Flamed
 Matte Sensitech
 20x120 cm | 7⁷/₈"x47¹/₄"

WALL
Vest
 Ecu
 Matte
 120x278 cm | 47¹/₄"x109¹/₂"

Log Select
 Moka Flamed
 Matte Sensitech
 20x120 cm | 7⁷/₈"x47¹/₄"

FURNITURE
Atlas Plan
 Nero Marquina
 Polished
 162x324 cm | 63³/₄"x127¹/₂"

DINING TABLE | **INCONTRO 75**
 Atlas Concorde Habitat
 Nero Marquina
 Polished
 100x180 cm | 39³/₈"x70⁷/₈"

TRAY | **TRATTO - QUADRO | DISCO**
 Atlas Concorde Habitat
 Boost Vision Camel - Ambrosia
 Hammered
 36x36 - ø 36 cm | 14¹/₈"x14¹/₈" - ø 14¹/₈"

INDEX



INSPIRATION



IMAGE GALLERY



LIVING WITH TERRACE
 SPA IN&OUT
 HOME BATHROOM
 LIVING WITH GARDEN
 LUXURY BATHROOM
 CONCEPT STORE
 RESTAURANT
 HOME KITCHEN

SURFACE RANGE & TECHNICAL SPECS



ENJOY THE VIDEO



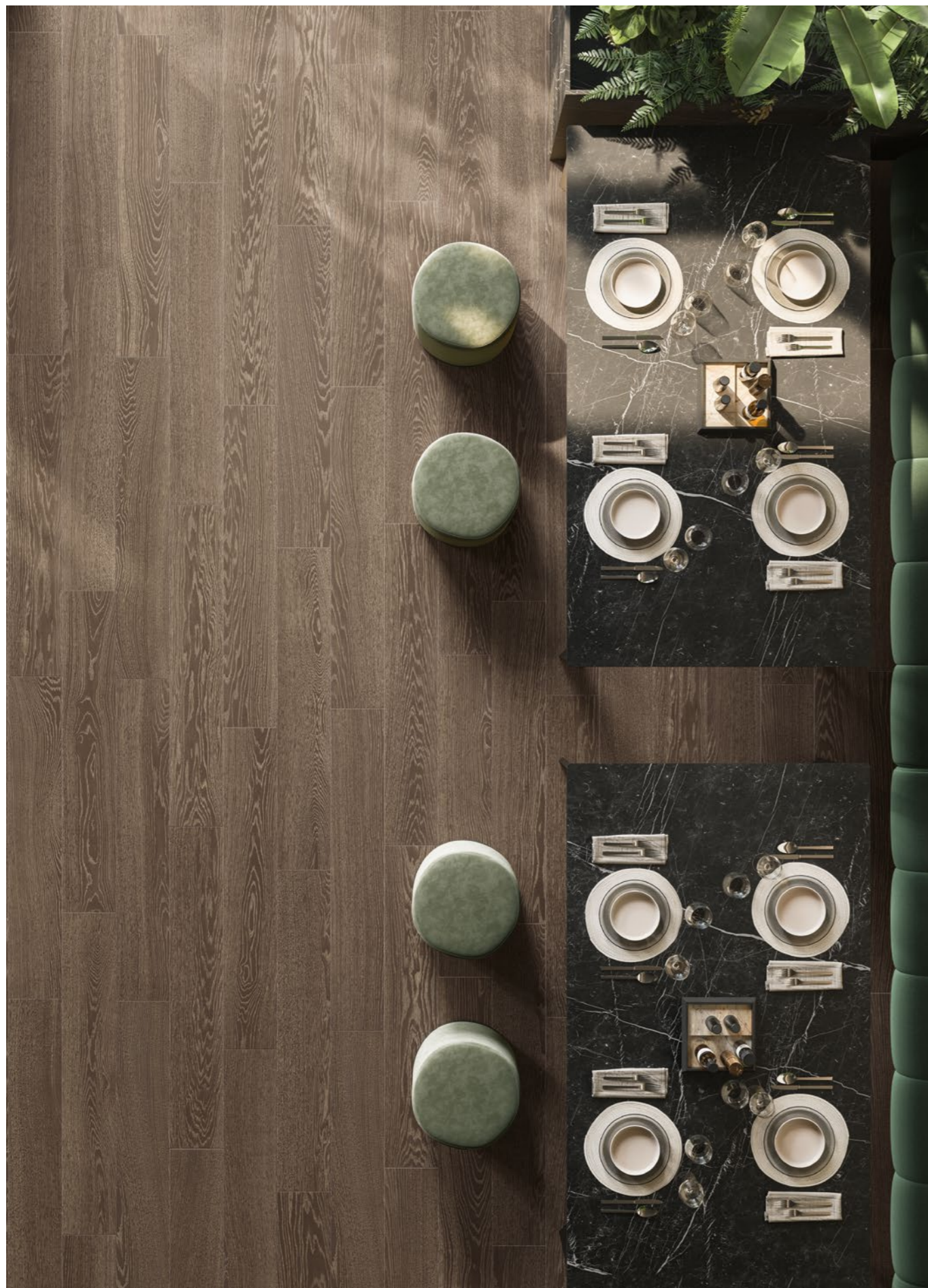

FLOOR
Log Select
Moka Flamed
 Matte Sensitech
 20x120 cm | 7⁷/₈"x47¹/₄"

WALL
Vest
Ecru
 Matte
 120x278 cm | 47¹/₄"x109¹/₂"

Log Select
Moka Flamed
 Matte Sensitech
 20x120 cm | 7⁷/₈"x47¹/₄"

DINING TABLE | **INCONTRO 75**
Atlas Concorde Habitat
Nero Marquina
 Polished
 100x180 cm | 39³/₈"x70⁷/₈"

TRAY | **TRATTO - QUADRO**
Atlas Concorde Habitat
Boost Vision Camel - Ambrosia
 Hammered
 25x25 cm - ø25 cm | 9⁷/₈"x9⁷/₈" - ø 9⁷/₈"

INDEX



INSPIRATION



IMAGE GALLERY



- LIVING WITH TERRACE
- SPA IN&OUT
- HOME BATHROOM
- LIVING WITH GARDEN
- LUXURY BATHROOM
- CONCEPT STORE
- RESTAURANT
- HOME KITCHEN

SURFACE RANGE & TECHNICAL SPECS



ENJOY THE VIDEO



INDEX



INSPIRATION



IMAGE
GALLERY



LIVING WITH TERRACE
SPA IN&OUT
HOME BATHROOM
LIVING WITH GARDEN
LUXURY BATHROOM
CONCEPT STORE
RESTAURANT
HOME KITCHEN

SURFACE
RANGE &
TECHNICAL
SPECS



ENJOY
THE VIDEO



SAWN



FLOOR
Log Select
 Ivory Sawn
 Matte Sensitech
 20x120 cm | 7⁷/₈"x47¹/₄"

WALL
Vest
 Cotton
 Matte
 120x278 cm | 47¹/₄"x109¹/₂"

FURNITURE
Atlas Plan
 Ambrosia
 Hammered
 162x324 cm | 63³/₄"x127¹/₂"

DINING TABLE | **BROOKLYN 75**
 Atlas Concorde Habitat
 Appennino
 Silk
 100x180 cm | 39¹/₈"x70⁷/₈"

TRAY | **TRATTO - DISCO**
 Atlas Concorde Habitat
 Nero Marquina
 Polished - Silk
 ø 25 - 36 cm | 9⁷/₈" - 14¹/₈"

INDEX



INSPIRATION



IMAGE GALLERY



- LIVING WITH TERRACE
- SPA IN&OUT
- HOME BATHROOM
- LIVING WITH GARDEN
- LUXURY BATHROOM
- CONCEPT STORE
- RESTAURANT
- HOME KITCHEN

SURFACE RANGE & TECHNICAL SPECS



ENJOY THE VIDEO





^
WALL
Vest
Cotton
Matte
120x278 cm | 47¹/₄"x109¹/₂"

<
FLOOR
Log Select
Ivory Sawn
Matte Sensitech
20x120 cm | 7⁷/₈"x47¹/₄"

FURNITURE
Atlas Plan
Ambrosia
Hammered
162x324 cm | 63³/₄"x127¹/₂"

TRAY | **TRATTO - DISCO**
Atlas Concorde Habitat
Nero Marquina
Polished - Silk
ø 25 - 36 cm | 9⁷/₈" - 14¹/₈"

INDEX 



INSPIRATION 

IMAGE GALLERY 

- LIVING WITH TERRACE
- SPA IN&OUT
- HOME BATHROOM
- LIVING WITH GARDEN
- LUXURY BATHROOM
- CONCEPT STORE
- RESTAURANT
- HOME KITCHEN

SURFACE RANGE & TECHNICAL SPECS 

ENJOY THE VIDEO 



SURFACE RANGE & TECHNICAL SPECIFICATIONS

◇
LOG SELECT RANGE

◇
TECHNICAL SPECIFICATIONS

◇
LOG WORLD

◇
SENSITECH TECHNOLOGY



PURE

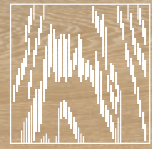

FLAMED



SAWN

INDEX



INSPIRATION



IMAGE GALLERY



SURFACE RANGE & TECHNICAL SPECS



LOG SELECT RANGE
TECHNICAL SPECIFICATIONS
LOG WORLD
SENSITECH TECHNOLOGY

LOG SELECT

PORCELAIN TILES - Gres Porcellanato - Grès cérame - Feinsteinzeug - Gres porcelánico - Керамический гранит
RECTIFIED MONOCALIBER - Rettificato monocalibro - Rectifié mono-calibre - Geschliffen einkalibrig - Rectificado monocalibre - Ретифицированный в одном калибре

PURE SELECTION

Floor Wall

		Ivory Pure	Bright Pure	Icon Pure	Amber Pure	Moon Pure
20x180 cm - 7 ⁷ / ₈ "x70 ⁷ / ₈ "	± 9,5 mm		Matte Sensitech	Matte Sensitech	Matte Sensitech	
20x120 cm - 7 ⁷ / ₈ "x47 ¹ / ₄ "	± 9 mm	Matte Sensitech	Matte Sensitech	Matte Sensitech	Matte Sensitech	Matte Sensitech
18,5x150 cm - 7 ¹ / ₄ "x59"	± 9 mm	Matte Sensitech	Matte Sensitech	Matte Sensitech	Matte Sensitech	Matte Sensitech
		Outdoor				
20x120 cm - 7 ⁷ / ₈ "x47 ¹ / ₄ "	± 9 mm		Grip Sensitech	Grip Sensitech	Grip Sensitech	

FLAMED SELECTION

Floor Wall

		White Flamed	Bright Flamed	Icon Flamed	Moka Flamed	Silver Flamed
20x120 cm - 7 ⁷ / ₈ "x47 ¹ / ₄ " ID Skin	± 9 mm	Matte Sensitech	Matte Sensitech	Matte Sensitech	Matte Sensitech	Matte Sensitech
18,5x150 cm - 7 ¹ / ₄ "x59"	± 9 mm	Matte Sensitech	Matte Sensitech	Matte Sensitech	Matte Sensitech	Matte Sensitech
		Outdoor				
20x120 cm - 7 ⁷ / ₈ "x47 ¹ / ₄ " ID Skin	± 9 mm		Grip Sensitech	Grip Sensitech		Grip Sensitech
30x120 cm - 11 ³ / ₄ "x47 ¹ / ₄ "	± 20 mm			Outdoor Sensitech		Outdoor Sensitech

SAWN SELECTION

Floor Wall

		Ivory Sawn	Bright Sawn	Icon Sawn	ID Skin
20x120 cm - 7 ⁷ / ₈ "x47 ¹ / ₄ " ID Skin	± 9 mm	Matte Sensitech	Matte Sensitech	Matte Sensitech	ID Skin This surface enhances the details and the fine texture of the product. La superficie esalta i dettagli e la matericità del prodotto.

VEST

WALL TILES - Rivestimenti - Revêtements - Wandfliesen - Revestimientos - Настенная плитка
PORCELAIN TILES - Gres porcellanato - Grès cérame - Feinsteinzeug - Gres porcelánico - Керамический гранит
RECTIFIED MONOCALIBER - Rettificato monocalibro - Rectifié mono calibre - Geschliffen einkalibrig - Rectificado monocalibre - Ретифицированный в одном калибре

Wall Tiles

		Cotton	Linen	Ecru	3D Qube White	3d Qube Glam
50x120 cm - 19 ⁵ / ₈ "x47 ¹ / ₄ "	± 8,5 mm	Matte	Matte	Matte		
50x120 cm - 19 ⁵ / ₈ "x47 ¹ / ₄ " 3D Qube	± 10 mm				Matte	Matte

Porcelain Tiles

120x278 cm - 47 ¹ / ₄ "x109 ¹ / ₂ " ID Skin	± 6 mm	Matte	Matte	Matte		
---	--------	-------	-------	-------	--	--

Destination of use

M Matte ± 6 mm	H Matte Sensitech ± 9-9.5 mm Grip Sensitech ± 9 mm Outdoor Sensitech ± 20 mm
-----------------------	---

Anti-slip

R9 A Matte ± 6 mm	R10 A+B Matte Sensitech ± 9-9.5 mm
R11 C Grip Sensitech ± 9 mm	R11 C Outdoor Sensitech ± 20 mm

Color-shading

V2 Slight Variation
All colors

Sensitech

ENJOY THE VIDEO



PURE

V2 Slight Variation

PORCELAIN TILES - Gres Porcellanato - Grès cérame - Feinsteinzeug - Gres porcelánico - Керамический гранит
RECTIFIED MONOCALIBER - Rettificato monocalibro - Rectifié mono-calibre - Geschliffen einkalibrig - Rectificado monocalibre - Ретифицированный в одном калибре

Ivory Pure



Bright Pure



Icon Pure



Amber Pure



Moon Pure



20x180 cm
7⁷/₈"x70⁷/₈"
Matte [Sensitech](#)
± 9,5 mm

Available in:
Bright Pure, Icon Pure,
Amber Pure.



18,5x150 cm
7¹/₄"x59"
Matte [Sensitech](#)
± 9 mm



20x120 cm
7⁷/₈"x47¹/₄"
Matte [Sensitech](#)
± 9 mm



20x120 cm
7⁷/₈"x47¹/₄"
Grip [Sensitech](#)
± 9 mm

Available in:
Bright Pure, Icon Pure,
Amber Pure.

INDEX



INSPIRATION



IMAGE GALLERY



SURFACE RANGE & TECHNICAL SPECS



LOG SELECT RANGE
TECHNICAL SPECIFICATIONS
LOG WORLD
SENSITECH TECHNOLOGY

ENJOY THE VIDEO



FLAMED

V2 Slight Variation

PORCELAIN TILES - Gres Porcellanato - Grès cérame - Feinsteinzeug - Gres porcelánico - Керамический гранит
RECTIFIED MONOCALIBER - Rettificato monocalibro - Rectifié mono-calibre - Geschliffen einkalibrig - Rectificado monocalibre - Ретифицированный в одном калибре

White Flamed



Bright Flamed



Icon Flamed



Moka Flamed



Silver Flamed



20x120 cm
7⁷/₈"x47¹/₄"
Matte [Sensitech](#)
± 9 mm



18,5x150 cm
7¹/₄"x59"
Matte [Sensitech](#)
± 9 mm



20x120 cm
7⁷/₈"x47¹/₄"
Grip [Sensitech](#)
± 9 mm
Available in:
Bright Flamed, Icon Flamed,
Silver Flamed

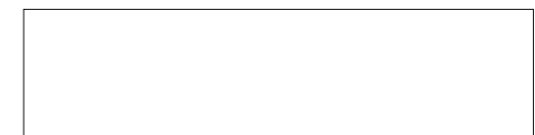

30x120 cm
11³/₄"x47¹/₄"
Outdoor [Sensitech](#)
± 20 mm
Available in:
Icon Flamed,
Silver Flamed

INDEX



INSPIRATION



IMAGE GALLERY



SURFACE RANGE & TECHNICAL SPECS



LOG SELECT RANGE
TECHNICAL SPECIFICATIONS
LOG WORLD
SENSITECH TECHNOLOGY

ENJOY THE VIDEO



SAWN

V2 Slight Variation

PORCELAIN TILES - Gres Porcellanato - Grès cérame - Feinsteinzeug - Gres porcelánico - Керамический гранит
RECTIFIED MONOCALIBER - Rettificato monocalibro - Rectifié mono-calibre - Geschliffen einkalibrig - Rectificado monocalibre - Ретифицированный в одном калибре

Ivory Sawn



Bright Sawn



Icon Sawn



20x120 cm
77/8" x 47 1/4"
Matte [Sensitech](#)
± 9 mm

INDEX



INSPIRATION



IMAGE
GALLERY



SURFACE
RANGE &
TECHNICAL
SPECS



LOG SELECT RANGE
TECHNICAL SPECIFICATIONS
LOG WORLD
SENSITECH TECHNOLOGY

ENJOY
THE VIDEO



VEST Big Slabs

V2 Slight Variation

PORCELAIN TILES - Gres Porcellanato - Grès cérame - Feinsteinzeug - Gres porcelánico - Керамический гранит
RECTIFIED MONOCALIBER - Rettificato monocalibro - Rectifié mono-calibre - Geschliffen einkalibrig - Rectificado monocalibre - Ретифицированный в одном калибре

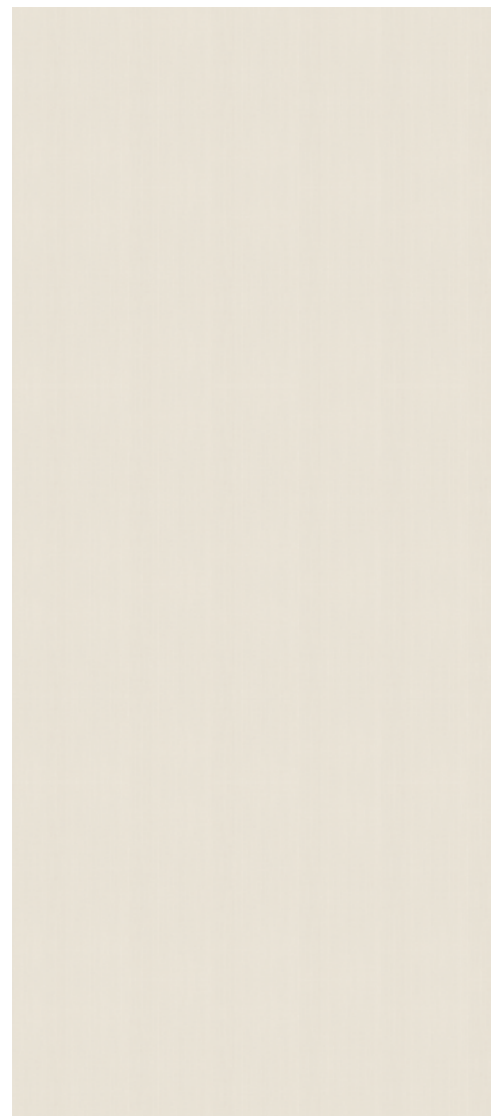

Vest Cotton
Matte
120x278 cm - 47 1/4" x 109 1/2"
± 6 mm



Vest Linen
Matte
120x278 cm - 47 1/4" x 109 1/2"
± 6 mm

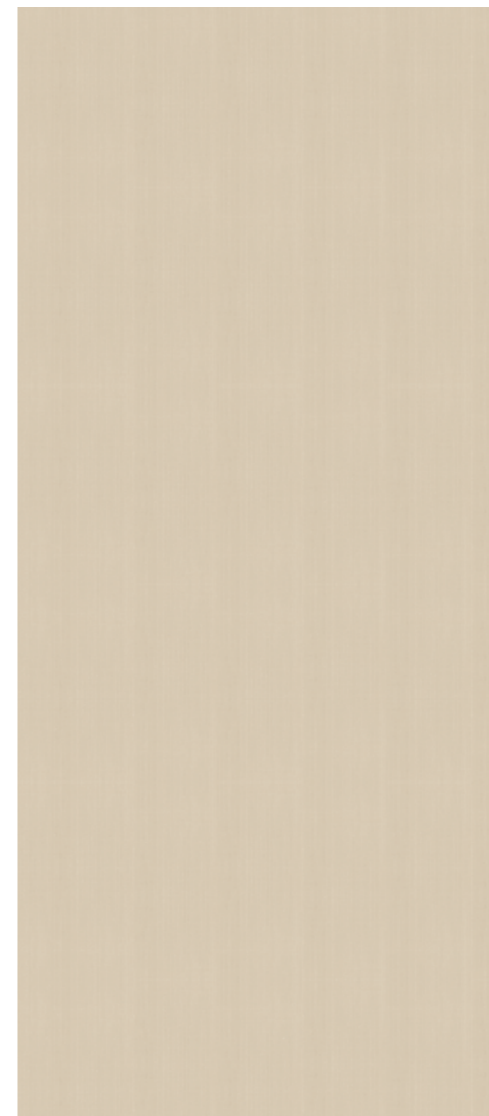

Vest Ecrú
Matte
120x278 cm - 47 1/4" x 109 1/2"
± 6 mm

Vest Breath •



Vest Breath
Matte
120x278 cm - 47 1/4" x 109 1/2"
± 6 mm

♦ **Graphic pattern. Misalignments in the continuity between different patterns is normal for this type of product.**
Decoro grafico. Eventuali disallineamenti nella continuità tra grafiche diverse sono una caratteristica intrinseca di questa tipologia di prodotto.

INDEX

INSPIRATION

IMAGE GALLERY

SURFACE RANGE & TECHNICAL SPECS

LOG SELECT RANGE
TECHNICAL SPECIFICATIONS
LOG WORLD
SENSITECH TECHNOLOGY

ENJOY THE VIDEO

VEST Wall Tiles

V2 Slight Variation

WALL TILES - Rivestimenti - Revêtements - Wandfliesen - Revestimientos - Настенная плитка
RECTIFIED MONOCALIBER - Rettificato monocalibro - Rectifié mono-calibre - Geschliffen einkalibrig - Rectificado monocalibre - Ретифицированный в одном калибре

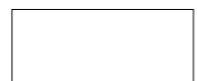

50x120 cm
19⁵/₈"x47¹/₄"

± 8,5 mm



Vest Cotton
Matte
50x120 cm - 19⁵/₈"x47¹/₄"



Vest Linen
Matte
50x120 cm - 19⁵/₈"x47¹/₄"



Vest Ecrú
Matte
50x120 cm - 19⁵/₈"x47¹/₄"



Vest 3D Qube DESIGN BY HBA

V2 Slight Variation

WALL TILES - Rivestimenti - Revêtements - Wandfliesen - Revestimientos - Настенная плитка
RECTIFIED MONOCALIBER - Rettificato monocalibro - Rectifié mono-calibre - Geschliffen einkalibrig - Rectificado monocalibre - Ретифицированный в одном калибре

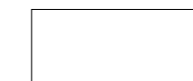

50x120 cm
19⁵/₈"x47¹/₄"

± 10 mm

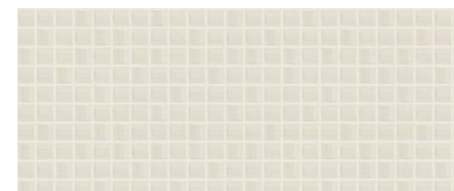

3D Vest Qube White
Matte
50x120 cm - 19⁵/₈"x47¹/₄"

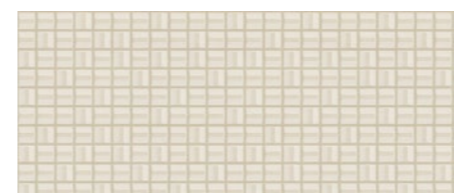

3D Vest Qube Glam
Matte
50x120 cm - 19⁵/₈"x47¹/₄"



INDEX



INSPIRATION



IMAGE GALLERY



SURFACE RANGE & TECHNICAL SPECS



LOG SELECT RANGE
TECHNICAL SPECIFICATIONS
LOG WORLD
SENSITECH TECHNOLOGY

ENJOY THE VIDEO



Trim tiles

Porcelain trim tiles

Battiscopa Matte Sensitech

7,2x120 cm - 2⁷/₈"x47¹/₄"
7,2x150 cm - 2⁷/₈"x59" *

Scalino Matte Sensitech ✓

33x120 cm - 13"x47¹/₄"
33x150 cm - 13"x59" *

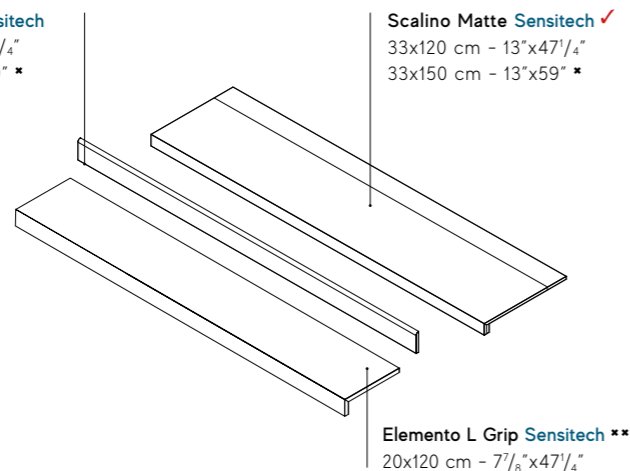

Elemento L Grip Sensitech **

20x120 cm - 7⁷/₈"x47¹/₄"

* Available in / Disponibile in Bright Pure, Icon Pure, Amber Pure, Ivory Pure, Moon Pure, Bright Flamed, Icon Flamed, White Flamed, Moka Flamed, Silver Flamed

** Available in / Disponibile in Bright Pure, Icon Pure, Amber Pure, Bright Flamed, Icon Flamed, Silver Flamed

✓ These parts are supplied to order / I pezzi sono disponibili su ordinazione

Wall trim tiles

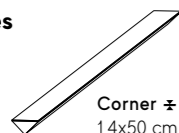

Corner ± 8,5 mm ✓
1,4x50 cm - 5⁵/₈"x19⁵/₈"



Corner A.E. ± 8,5 mm ✓
1,4x1,4 cm - 5⁵/₈"x5⁵/₈"

✓ These parts are supplied to order / I pezzi sono disponibili su ordinazione

Outdoor trim tiles ± 20 mm



Round
Outdoor Sensitech SP * ♦ ✓
30x120 cm - 11³/₄"x47¹/₄"

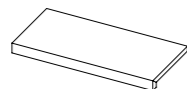

Elemento L
Outdoor Sensitech SP * ✓
20x120 cm - 7⁷/₈"x47¹/₄"

* Available in / Disponibile in Icon Flamed, Silver Flamed

✓ These parts are supplied to order / I pezzi sono disponibili su ordinazione

♦ Right-left angular elements are available / Sono disponibili gli elementi angolari dx/sx

Outdoor Porcelain tiles ± 20 mm

For further details on the 20mm thick products, related trim pieces and installation systems - in particular for recommendations and precautions during installation- please refer to the Outdoor Design section on the Atlas Concorde website or to the Outdoor Design catalogue. Per dettagli sul prodotto e sui relativi pezzi speciali in 20mm di spessore, per i sistemi di posa e, in particolare, per raccomandazioni, accorgimenti e precauzioni in fase di posa e progettazione, si raccomanda di prendere visione del catalogo Outdoor Design e della sezione Outdoor Design del sito Atlas Concorde.

Laying tips

Stagger the planks at a maximum of 40 cm. It's best to stagger the tiles randomly (see the illustration).

Consigli per la posa. Sfalsare i listoni di 40 cm al massimo. Si consiglia di sfalsare le piastrelle in maniera irregolare. (vedi figura).

Conseils pour la pose. Décaler les listels de 40 cm maximum. Nous conseillons de décaler les carreaux de manière irrégulière. (voir la figure).

Tipps für die Verlegung. Die Dielen maximal um 40 cm versetzt verlegen. Es empfiehlt sich, die Fliesen in unregelmäßig versetztem Verband zu verlegen (siehe Abbildung).

Recomendaciones para la instalación. Escalonar los listones un máximo de 40 cm. Se recomienda escalonar los azulejos de forma irregular (véase figura).

Рекомендации по укладке. Рекомендуется укладывать плитку со смещением не более 40 см. Кроме того, желательно смещать плитки неравномерно (см. рисунок).

Recommended laying patten - Schema di posa consigliato

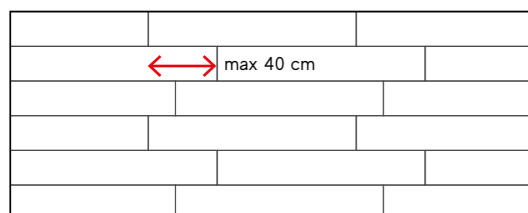

Not recommended laying patten - Schema di posa scongiato

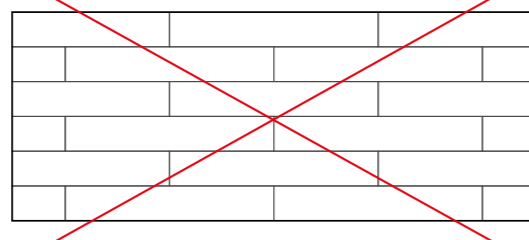

THANKS TO

ITLAS

itlas.com

Note

For information and details relating to codes, packaging and weight it is recommended to refer to the latest pricelist. - Per le informazioni e i dati relativi a codici, imballaggi e pesi occorre sempre consultare l'ultimo listino aggiornato e in vigore. - Pour toutes informations et renseignements concernant les codes, les emballages et les poids, il y a toujours lieu de consulter le dernier tarif en vigueur et mis à jour. - Für Informationen und Daten die den Code, die Verpackung und das Gewicht betreffen bitte die aktuellste Preisliste zugrunde legen. - Para acceder a la información y a los datos relativos a códigos, embalajes y pesos hay que consultar siempre la última lista de precios actualizada y vigente. - Для информации о кодах, упаковках и весе обращайтесь к последнему действующему прайс-листу.

Colors and optical features of the materials illustrated in this catalogue are to be regarded as mere indications. - I colori e le caratteristiche estetiche dei materiali illustrati nel presente catalogo sono da ritenersi puramente indicativi. - Les coloris et les caractéristiques esthétiques des références illustrées dans le catalogue sont donnés à titre purement indicatif. - Die Farben und die ästhetischen Eigenschaften der in diesem Katalog abgebildeten Produkte sind als reine Richtwerte zu betrachten. - Los colores y las características estéticas de los materiales ilustrados en el presente catálogo deben ser considerados como puramente indicativos. - Цвета и эстетические характеристики описанных в настоящем каталоге материалов являются только ориентировочными.

Atlas Concorde reserves the right to modify any product without notice and will not be liable for any direct or indirect damage resulting from such modifications. - Atlas Concorde si riserva di modificare i prodotti senza preavviso, declinando ogni responsabilità su eventuali danni diretti o indiretti derivanti da eventuali modifiche. - Atlas Concorde se réserve le droit de modifier ses produits sans préavis et décline toute responsabilité concernant les éventuels dommages directs ou indirects qui pourraient dériver de ces modifications. - Atlas Concorde behält sich das Recht vor jederzeit und ohne vorherige Ankündigung, die Produkte zu verändern, und lehnt jede Haftung bei direkten oder indirekten Schäden ab, die von diesen Veränderungen herrühren. - Atlas Concorde se reserva el derecho de modificar los productos sin previo aviso, rechaza cualquier responsabilidad sobre eventuales daños directos o indirectos derivados de eventuales modificaciones. - Atlas Concorde оставляет за собой право изменять характеристики изделий без предварительного уведомления, отклоняя при этом любую ответственность за прямые или косвенные убытки, возникшие в результате изменений.

INDEX



INSPIRATION



IMAGE
GALLERY



SURFACE
RANGE &
TECHNICAL
SPECS



LOG SELECT RANGE
TECHNICAL SPECIFICATIONS
LOG WORLD
SENSITECH TECHNOLOGY

ENJOY
THE VIDEO





Porcelain tiles - Rectified monocaliber

Compliant with standards EN 14411 annex G group B1a
Compliant with standards ISO 13006 annex G group B1a
Conforme alla norma EN 14411 Appendice G gruppo B1a
Conforme alla norma ISO 13006 Appendice G gruppo B1a

Gres porcellanato - Rettificato monocalibro

20x180 cm - 7 7/8" x 70 7/8"
20x120 cm - 7 7/8" x 47 1/4"
18.5x150 cm - 7 1/4" x 59"
30x120 cm - 11 1/4" x 47 1/4"
9,5 mm
9 mm
9 mm
20 mm



Wall tiles - Rectified monocaliber
Rivestimento - Rettificato monocalibro

Compliant with standards EN 14411 annex L group B11
Compliant with standards ISO 13006 annex L group B11
Conforme alla norma EN 14411 Appendice L gruppo B11
Conforme alla norma ISO 13006 Appendice L gruppo B11

50x120 cm - 19 3/8" x 47 1/4"
± 8,5 mm
50x120 cm - 19 3/8" x 47 1/4"
± 10 mm



Porcelain tiles - Rectified monocaliber
Gres porcellanato - Rettificato monocalibro

Compliant with standards EN 14411 annex G group B1a
Compliant with standards ISO 13006 annex G group B1a
Conforme alla norma EN 14411 Appendice G gruppo B1a
Conforme alla norma ISO 13006 Appendice G gruppo B1a



Technical features Caratteristiche tecniche	Test Method Metodo di prova	Requirements for nominal size N / Requisiti per dimensione nominale N			Porcelain tiles		
		7 cm ≤ N < 15 cm	N ≥ 15 cm		Matte Sensitech ± 9-9,5 mm	Grip Sensitech ± 9 mm	Outdoor Sensitech ± 20 mm
		(mm)	(%)	(mm)			
Length and width Lunghezza e larghezza		± 0,9 (*) Non-rect. ± 0,4 (*) Rect.	± 0,6 (*) Non-rect. ± 0,3 (*) Rect.	± 2,0 (*) Non-rect. ± 1,0 (*) Rect.	Suitable for Conforme	Suitable for Conforme	Suitable for Conforme
Thickness Spessore		± 0,5 (**)	± 5 (***)	± 0,5 (***)	Suitable for Conforme	Suitable for Conforme	Suitable for Conforme
Straightness of sides Rettilineità degli spigoli	ISO 10545-2	± 0,8 (***) Non-rect. ± 0,4 (***) Rect.	± 0,5 (***) Non-rect. ± 0,3 (***) Rect.	± 1,5 (***) Non-rect. ± 0,8 (***) Rect.	Suitable for Conforme	Suitable for Conforme	Suitable for Conforme
Rectangularity (Measurement only on short edges when L/1 ≥ 3) Ortogonalità (Misurazione da condurre solo sui lati corti quando L/1 ≥ 3)		± 0,8 (***) Non-rect. ± 0,4 (***) Rect.	± 0,5 (***) Non-rect. ± 0,3 (***) Rect.	± 2,0 (***) Non-rect. ± 1,5 (***) Rect.	Suitable for Conforme	Suitable for Conforme	Suitable for Conforme
Surface flatness Planarità	ISO 10545-2	c.c. ± 0,8 Non-rect. c.c. ± 0,6 Rect. e.c. ± 0,8 Non-rect. e.c. ± 0,6 Rect. w. ± 0,8 Non-rect. w. ± 0,6 Rect.	c.c. ± 0,5 Non-rect. c.c. ± 0,4 Rect. e.c. ± 0,5 Non-rect. e.c. ± 0,4 Rect. w. ± 0,5 Non-rect. w. ± 0,4 Rect.	c.c. ± 2,0 Non-rect. c.c. ± 1,8 Rect. e.c. ± 2,0 Non-rect. e.c. ± 1,8 Rect. w. ± 2,0 Non-rect. w. ± 1,8 Rect.	Suitable for Conforme	Suitable for Conforme	Suitable for Conforme
Water absorption (in% by mass) Massa d'acqua assorbita (come % della massa)	ISO 10545-3 ASTM C373	E _v ≤ 0,5% Individual Maximum 0,6% E _v ≤ 0,5% Valore massimo singolo 0,6%			≤ 0,1 %	≤ 0,1 %	≤ 0,1 %
Breaking strength Sforzo di rottura	ISO 10545-4	S ≥ 700N (for thickness < 7,5 mm - per spessore < 7,5 mm) S ≥ 1300N (for thickness ≥ 7,5 mm - per spessore ≥ 7,5 mm)			S ≥ 1500 N	S ≥ 1500 N	S ≥ 10000 N
Modulus of rupture Resistenza alla flessione		R ≥ 35 N/mm ²			R ≥ 40 N/mm ²	R ≥ 40 N/mm ²	R ≥ 45 N/mm ²
Bending strength and breaking load Resistenza a flessione e al carico di rottura (4)(5)	EN 1339 Annex F	-			-	-	≥ U3 30x120
Impact resistance, as coefficient of restitution Resistenza all'impatto, espresso come coefficiente di restituzione	ISO 10545-5	Declared value Valore dichiarato			≥ 0,55	≥ 0,55	≥ 0,55
Resistance to deep abrasion of unglazed tiles (removed volume) Resistenza all'abrasione profonda delle piastrelle non smaltate (volume materiale asportato)	ISO 10545-6	≤ 175 mm ³			≤ 150 mm ³	≤ 150 mm ³	≤ 150 mm ³
Coefficient of thermal linear expansion Coefficiente di dilatazione termica lineare	ISO 10545-8	Declared value Valore dichiarato			≤ 7MK ⁻¹	≤ 7MK ⁻¹	≤ 7MK ⁻¹
Thermal shock resistance Resistenza agli sbalzi termici	ISO 10545-9	Pass according to EN ISO 10545-1 Test superato in accordo con ISO 10545-1			Resistant Resiste	Resistant Resiste	Resistant Resiste
Moisture expansion (in mm/m) Dilatazione all'umidità (in mm/m)	ISO 10545-10	Declared value Valore dichiarato			≤ 0,01% (0,1mm/m)	≤ 0,01% (0,1mm/m)	≤ 0,01% (0,1mm/m)
Frost resistance Resistenza al gelo	ISO 10545-12	Pass according to EN ISO 10545-1 Test superato in accordo con ISO 10545-1			Resistant Resiste	Resistant Resiste	Resistant Resiste
Bond strength / adhesion for Cementitious Adhesives Adesione mediante trazione su adesivi cementizi	EN 12004-2	Declared value Valore dichiarato			≥ 1,0 N/mm ² (Class C2 - EN 12004)	≥ 1,0 N/mm ² (Class C2 - EN 12004)	≥ 1,0 N/mm ² (Class C2 - EN 12004)
Reaction to fire Reazione al fuoco	-	Class A1 or A1 _f Classe A1 oppure A1 _f			A1 - A1 _f	A1 - A1 _f	A1 - A1 _f
Resistance to household chemicals and swimming pool salts Resistenza ai prodotti chimici di uso domestico e agli additivi per piscina		Minimum Class B Classe minima B			A	A	A
Resistance to low concentrations of acids and alkalis Resistenza a basse concentrazioni di acidi e alcali	ISO 10545-13	Declared Class Classe dichiarata			LA	LA	LA
Resistance to high concentrations of acids and alkalis Resistenza ad alte concentrazioni di acidi e alcali		Declared Class Classe dichiarata			HA	HA	HA
Resistance to staining, for unglazed tiles Resistenza alle macchie per piastrelle non smaltate	ISO 10545-14	Declared Class Classe dichiarata			5	5	5
Shood Ramp Test Metodo della rampa "calzato"	DIN EN 16165 ANNEX B (EX DIN 51130)	Declared value Valore dichiarato			R10	R11	R11
Barefoot Ramp Test Metodo della rampa a piedi nudi	DIN EN 16165 ANNEX A (EX DIN 51097)	Declared value Valore dichiarato			A+B	A+B+C	A+B+C
	BS EN 16165 ANNEX C (EX BS 7976)	PTV ≥ 36 classifies the surface as 'low slip risk'			≥ 36 Dry ≥ 36 Wet	≥ 36 Dry ≥ 36 Wet	≥ 36 Dry ≥ 36 Wet
Pendulum Friction Test Metodo del Pendolo	AS 4586	Declared Classification of the new pedestrian surface materials according to the Pendulum Test			Class P3	Class P4	Class P4
	UNE EN 16165 ANNEX C (EX UNE 41901 EX 2017)	Declared value Valore dichiarato			Class C2	Class C3	Class C3
Coefficient of friction (COF) Coefficiente di attrito	B.C.R.A. Rep. CEC/81	D. M. 236/89 del 14/06/89 μ > 0,40 per elemento scivolante cuoio su pavimentazione asciutta μ > 0,40 per elemento scivolante gomma dura su pavimentazione bagnata			> 0,40 Asciutto > 0,40 Bagnato	> 0,40 Asciutto > 0,40 Bagnato	> 0,40 Asciutto > 0,40 Bagnato
Dynamic coefficient of friction (DCOF) Coefficiente di attrito dinamico	ANSI A 326,3	-			wet DCOF ≥ 0,50	wet DCOF ≥ 0,55	wet DCOF ≥ 0,55

(*) The permissible deviation, in % or mm, of the average size for each tile (2 or 4 sides) from work size (WS). Deviazione ammissibile, in % oppure mm, della dimensione media di ogni piastrella (2 oppure 4 lati) dalla dimensione di fabbricazione (WS).
 (***) The permissible deviation, in % or mm, of the average thickness for each tile from the work size thickness (WS). Deviazione ammissibile, in % oppure mm, dello spessore medio di ogni piastrella dalla spessore riportato nella dimensione di fabbricazione (WS).
 (***) The maximum permissible deviation from straightness, in % or mm, related to the corresponding work sizes (WS). Deviazione massima ammissibile di rettilineità, in % oppure mm, in rapporto alle dimensioni di fabbricazione (WS) corrispondenti.
 (***) The maximum permissible deviation from rectangularity, in % or mm, related to the corresponding work sizes (WS). Deviazione massima ammissibile di rettangolarità, in % oppure mm, in rapporto alle dimensioni di fabbricazione (WS) corrispondenti.
 c.c. The maximum permissible deviation from centre curvature, in % or mm, related to diagonal calculated from the work sizes (WS). Deviazione massima ammissibile della curvatura del centro, in % oppure mm, in rapporto alla diagonale calcolata secondo le dimensioni di fabbricazione (WS).
 e.c. The maximum permissible deviation from edge curvature, in % or mm, related to the corresponding work sizes (WS). Deviazione massima ammissibile della curvatura dello spigolo, in % oppure mm, in rapporto alle dimensioni di fabbricazione (WS) corrispondenti.
 w. The maximum permissible deviation from warpage, in % or mm, related to diagonal calculated from the work sizes (WS). Deviazione massima ammissibile dello sverglamento, in % oppure mm, in rapporto alla diagonale calcolata secondo le dimensioni di fabbricazione (WS).
 (1) Determination of slip resistance of pedestrian surfaces; it does not cover sports surfaces and road surfaces for vehicles (skid resistance). Determinazione della resistenza allo scivolamento delle superfici pedonabili; non si applica alle pavimentazioni sportive ed alle pavimentazioni stradali veicolari.
 (2) Anti-slip performance is guaranteed at the time of delivery of the product. Le prestazioni anti-slip vengono garantite al momento della consegna del prodotto.
 (4) For further details, please refer to outdoor design general catalogue. Per maggiori informazioni riferirsi al catalogo generale Outdoor Design.
 (5) Only for products with 20 mm thickness. Solo per prodotti a 20mm di spessore.
 (a) PTV ≥ 36 Wet on demand / su richiesta (**) P3 on demand / su richiesta (***) C2 on demand / su richiesta

Technical features Caratteristiche tecniche	Test Method Metodo di prova	Requirements for nominal size N Requisiti per dimensione nominale N			Wall tiles	Requirements for nominal size N Requisiti per dimensione nominale N			Porcelain tiles
		7 cm ≤ N < 15 cm	N ≥ 15 cm			7 cm ≤ N < 15 cm	N ≥ 15 cm		
		(mm)	(%)	(mm)		(mm)	(%)	(mm)	
Length and width Lunghezza e larghezza		± 0,4 (*) Rect.	± 0,3 (*) Rect.	± 1,0 (*) Rect.	Suitable for Conforme	± 0,9 (*) Non-rect. ± 0,4 (*) Rect.	± 0,6 (*) Non-rect. ± 0,3 (*) Rect.	± 2,0 (*) Non-rect. ± 1,0 (*) Rect.	Suitable for Conforme
Thickness Spessore	ISO 10545-2	± 0,5 (**)	± 10 (**)	± 0,5 (**)	Suitable for Conforme	± 0,5 (**)	± 0,5 (**)	± 0,5 (**)	Suitable for Conforme
Straightness of sides Rettilineità degli spigoli		± 0,4 (*) Rect.	± 0,3 (***) Rect.	± 0,8 (***) Rect.	Suitable for Conforme	± 0,8 (***) Non-rect. ± 0,4 (***) Rect.	± 0,5 (***) Non-rect. ± 0,3 (***) Rect.	± 2,0 (***) Non-rect. ± 0,8 (***) Rect.	Suitable for Conforme
Rectangularity Ortogonalità		± 0,4 (***) Rect.	± 0,3 (***) Rect.	± 1,5 (***) Rect.	Suitable for Conforme	± 0,8 (***) Non-rect. ± 0,4 (***) Rect.	± 0,5 (***) Non-rect. ± 0,3 (***) Rect.	± 2,0 (***) Non-rect. ± 1,5 (***) Rect.	Suitable for Conforme
Surface flatness Planarità	ISO 10545-2	c.c. ± 0,6 Rect. e.c. ± 0,6 Rect. w. ± 0,6 Rect.	c.c. ± 0,4 Rect. e.c. ± 0,4 Rect. w. ± 0,4 Rect.	c.c. ± 1,8 Rect. e.c. ± 1,8 Rect. w. ± 1,8 Rect.	Suitable for Conforme 3D WALL Non applicabile 3D WALL Non applicabile	cc. ± 0,8 Non-rect. cc. ± 0,6 Rect. w. ± 0,8 Non-rect. w. ± 0,6 Rect.	e.c. ± 0,5 Non-rect. e.c. ± 0,4 Rect. w. ± 0,5 Non-rect. w. ± 0,4 Rect.	e.c. ± 2,0 Non-rect. cc. ± 1,8 Rect. w. ± 2,0 Non-rect. w. ± 1,8 Rect.	Suitable for Conforme
Water absorption (in% by mass) Massa d'acqua assorbita (come % della massa)	ISO 10545-3 ASTM C373	Average >10%. When the average > 20%, this shall be indicated. Individual value > 9% Media >10%. Se questo valore > 20%, deve essere indicato. Valore Singolo > 9%			10% < E _v ≤ 20%	E _v ≤ 0,5% Individual Maximum 0,6% E _v ≤ 0,5% Valore massimo singolo 0,6%			≤ 0,1%
Breaking strength Sforzo di rottura		-			S ≥ 600 N	Requirement ANSI A1371-2017 Water absorption max ≤ 0,5%			≤ 0,5%
Modulus of rupture Resistenza alla flessione	ISO 10545-4	-			R ≥ 15 N/mm ²	S ≥ 700N (for thickness < 7,5 mm - per spessore < 7,5 mm) S ≥ 1300N (for thickness ≥ 7,5 mm - per spessore ≥ 7,5 mm)			S ≥ 1000 N
Bending strength and breaking load Resistenza a flessione e al carico di rottura (4)(5)		-			-	-			-
Impact resistance, as coefficient of restitution Resistenza all'impatto, espresso come coefficiente di restituzione	ISO 10545-5	-			-	Declared value Valore dichiarato			>= 0,55
Resistance to deep abrasion of unglazed tiles (removed volume) Resistenza all'abrasione profonda delle piastrelle non smaltate (volume materiale asportato)	ISO 10545-6	-			-	≤ 175 N/mm ³			≤ 150 N/mm ³
Coefficient of thermal linear expansion Coefficiente di dilatazione termica lineare	ISO 10545-8	-			Declared value Valore dichiarato	≤ 7MK ⁻¹			≤ 7MK ⁻¹
Thermal shock resistance Resistenza agli sbalzi termici	ISO 10545-9	Pass according to EN ISO 10545-1 Test superato in accordo con ISO 10545-1			Resistant Resiste	Pass according to EN ISO 10545-1 Test superato in accordo con ISO 10545-1			Resistant Resiste
Moisture expansion (in mm/m) Dilatazione all'umidità (in mm/m)	ISO 10545-10	-			Declared value Valore dichiarato	≤ 0,06% (0,6mm/m)			≤ 0,01% (0,1mm/m)
Frost resistance Resistenza al gelo	ISO 10545-12	Pass according to EN ISO 10545-1 Test superato in accordo con ISO 10545-1			Resistant Resiste	Pass according to EN ISO 10545-1 Test superato in accordo con ISO 10545-1			Resistant Resiste
Bond strength / adhesion for Cementitious Adhesives Adesione mediante trazione su adesivi cementizi	EN 12004-2	-			Declared value Valore dichiarato	≥ 1,0 N/mm ² (Class C2 - EN 12004)			-
Reaction to fire Reazione al fuoco	-	-			Class A1 Classe A1	Class A1 or A1 _f Classe A1 oppure A1 _f			A1 - A1 _f
Resistance to household chemicals and swimming pool salts Resistenza ai prodotti chimici di uso domestico e agli additivi per piscina		-			Minimum Class B Classe minima B	Minimum Class B Classe minima B			A
Resistance to low concentrations of acids and alkalis Resistenza a basse concentrazioni di acidi e alcali	ISO 10545-13	-			Declared Class Classe dichiarata	Declared Class Classe dichiarata			LA
Resistance to high concentrations of acids and alkalis Resistenza ad alte concentrazioni di acidi e alcali		-			Declared Class Classe dichiarata	Declared Class Classe dichiarata			HA
Resistance to staining, for unglazed tiles Resistenza alle macchie per piastrelle non smaltate	ISO 10545-14	-			Minimum Class 3 Classe 3 minima	Declared Class Classe dichiarata			5
Release of dangerous substances: Cadmium (in mg/dm²) and Lead (in mg/dm²) Rilascio di sostanze pericolose: Cadmio (in mg/dm ²) e Piombo (in mg/dm ²)	ISO 10545-15	-			Declared value Valore dichiarato	≤ 0,01 mg/dm ² Cd ≤ 0,1 mg/dm ² Pb			-
Shood Ramp Test Metodo della rampa "calzato"	DIN EN 16165 ANNEX B (EX DIN 51130)	-			-	Declared value Valore dichiarato			R9
Barefoot Ramp Test Metodo della rampa a piedi nudi	DIN EN 16165 ANNEX A (EX DIN 51097)	-			-	Declared value Valore dichiarato			A
	BS EN 16165 ANNEX C (EX BS 7976)	-			-	PTV ≥ 36 classifies the surface as 'low slip risk'			(a)
Pendulum Friction Test Metodo del Pendolo	AS 4586	-			-	Declared Classification of the new pedestrian surface materials according to the Pendulum Test			(**)
	UNE EN 16165 ANNEX C (EX UNE 41901 EX 2017)	-			-	Declared value Valore dichiarato			(***)
Coefficient of friction (COF) Coefficiente di attrito	B.C.R.A. Rep. CEC/81	-			-	D. M. 236/89 del 14/06/89 μ > 0,40 per elemento scivolante cuoio su pavimentazione asciutta μ > 0,40 per elemento scivolante gomma dura su pavimentazione bagnata			> 0,40 Asciutto > 0,40 Bagnato
Dynamic coefficient of friction (DCOF) Coefficiente di attrito dinamico	ANSI A 326,3	-			-	-			wet DCOF ≥ 0,42



Furniture in combination with Atlas Concorde surfaces

atlasconcorde.com >
ATLAS CONCORDE HABITAT 

Bathroom Furniture

Custom Elements

Essenza

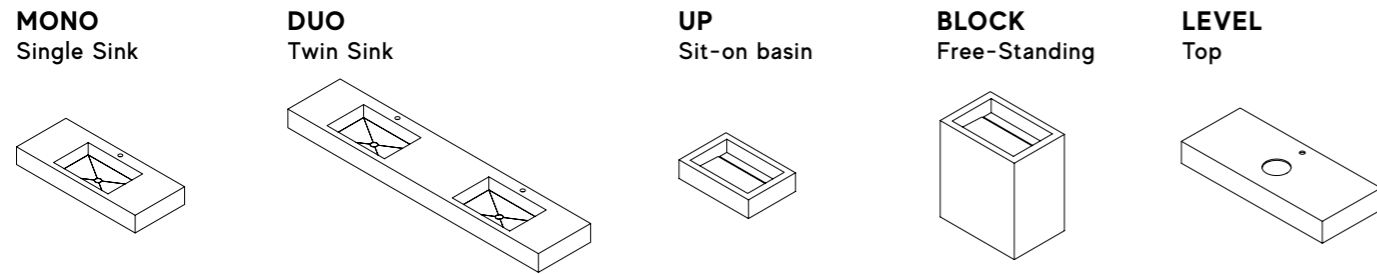

Evoluzione

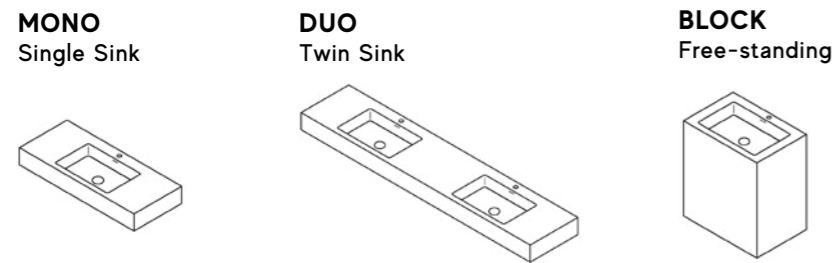

Dialogo

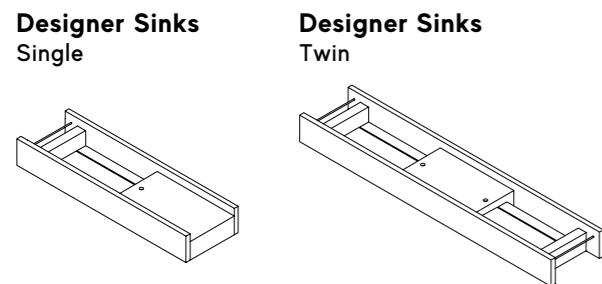

Armonia

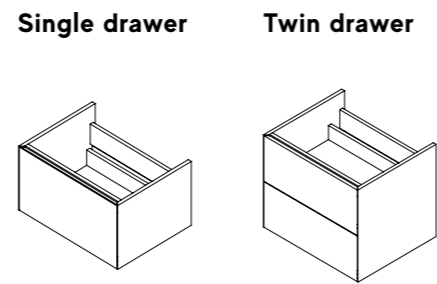

Tables

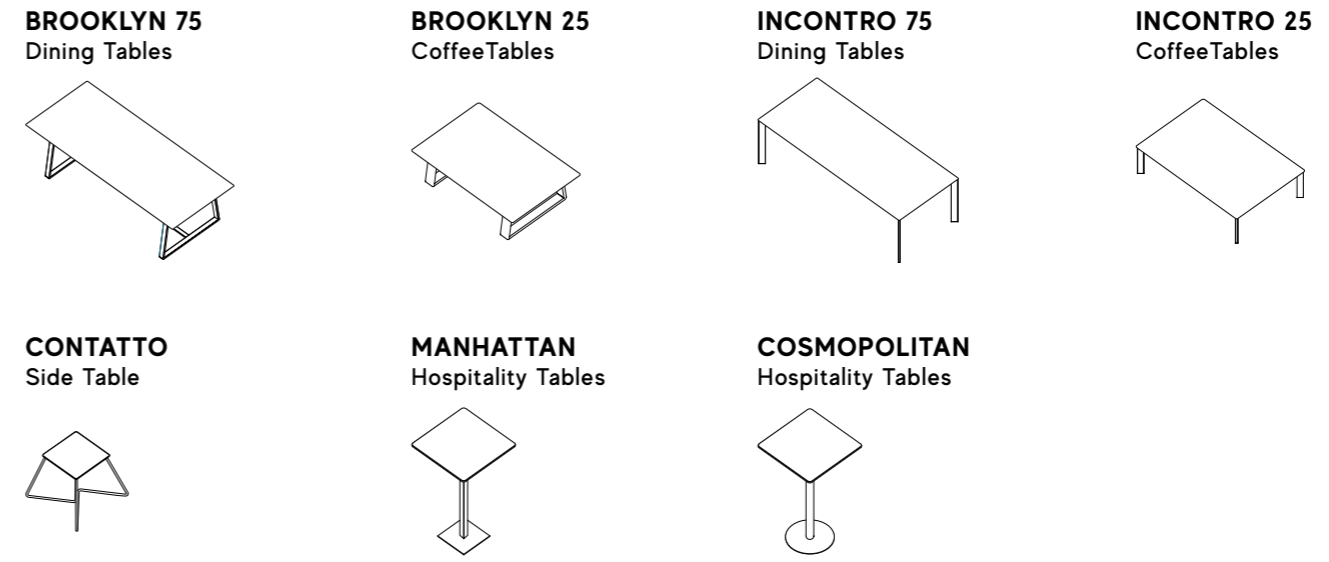

Signature Objects

BY PIERO LISSONI

Tratto

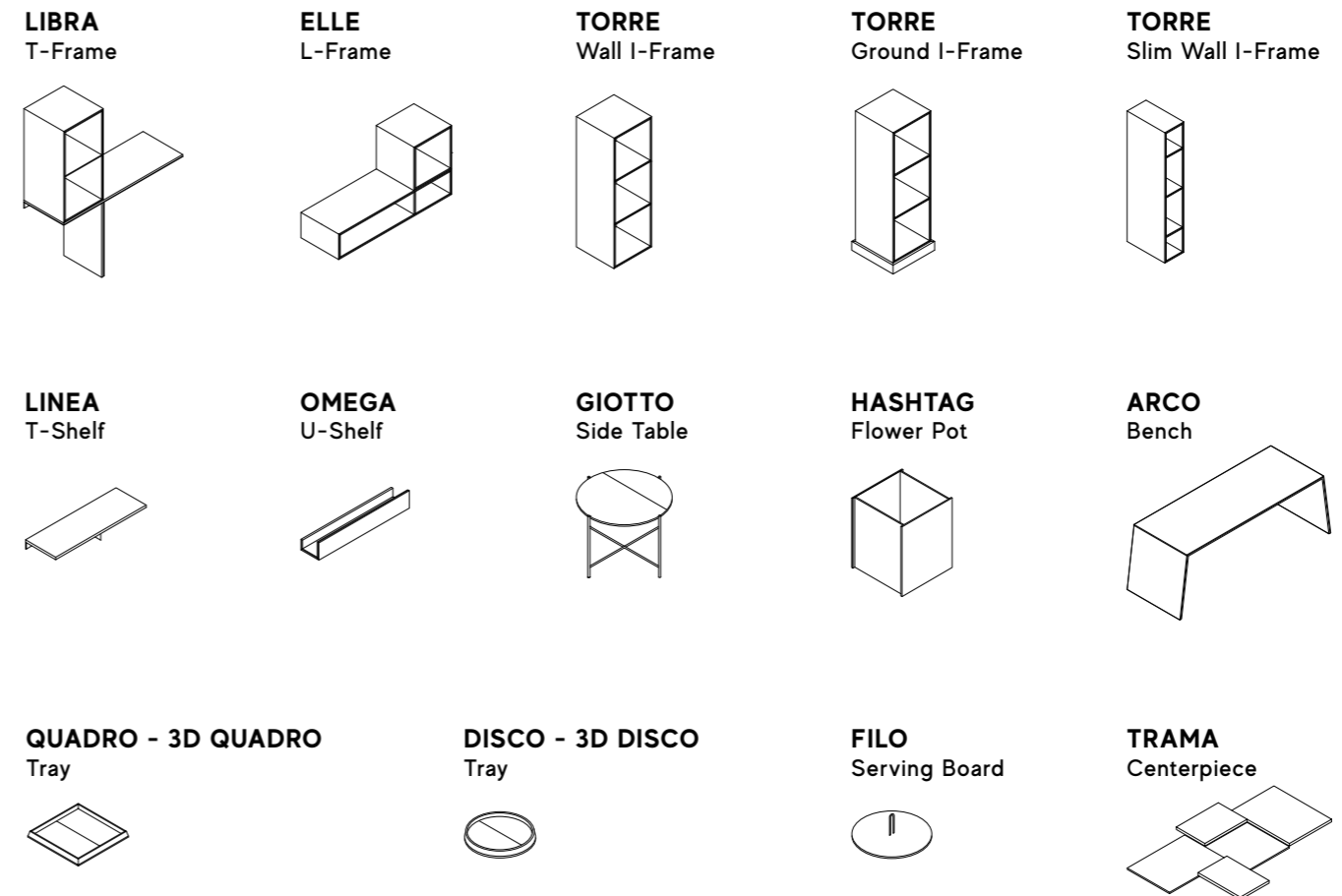

INDEX



INSPIRATION



IMAGE GALLERY



SURFACE RANGE & TECHNICAL SPECS



LOG SELECT RANGE
TECHNICAL SPECIFICATIONS
LOG WORLD
SENSITECH TECHNOLOGY

ENJOY THE VIDEO



LOGWORLD



LOG

Natural Oak

LOG

CANSEI

Unique Beech effect

LOG

SELECT

Selected Oak

The Atlas Concorde Wood Effect

DISCOVER
LOG WORLD



INDEX



INSPIRATION



IMAGE
GALLERY



SURFACE
RANGE &
TECHNICAL
SPECS



LOG SELECT RANGE
TECHNICAL SPECIFICATIONS
LOG WORLD
SENSITECH TECHNOLOGY

ENJOY
THE VIDEO



Sensitech

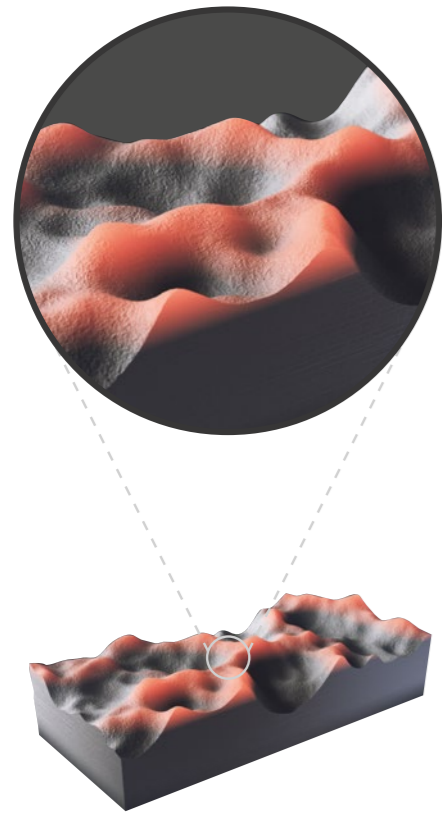

Traditional anti-slip surface

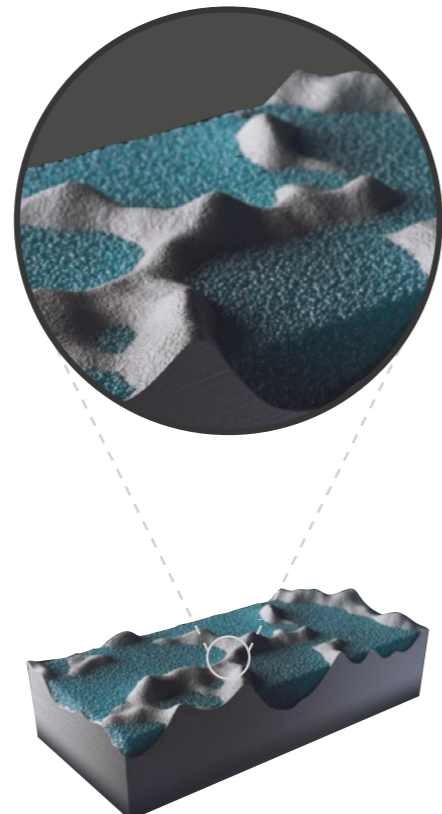

The innovative Sensitech Surface

Sensitech is the high-tech surface for indoor and outdoor settings created by Atlas Concorde Laboratories, patented in Europe and the United States. The surface combines high slip resistance performance with tactile softness. With Sensitech, the meaning of surface evolves and takes on a reassuring, pleasant and practical touch, making architectural spaces more comfortable and appealing.

Sensitech è la superficie ad alto coefficiente tecnologico per gli ambienti interni ed esterni realizzata dai Laboratori Atlas Concorde, brevettata in Europa e negli stati Uniti. La superficie coniuga elevate prestazioni di resistenza allo scivolamento ad una maggiore morbidezza tattile. Con Sensitech il significato di superficie si evolve e assume un tocco rassicurante, piacevole e pratico, rendendo gli spazi architettonici sempre più confortevoli e appaganti.



Ethical identity



For Atlas Concorde, being Made in Italy is not just a prestigious certification of style, design, and production excellence, but an identity that involves all aspects of its business. For this reason, we identify with the values expressed by Confindustria Ceramica's ethical code, which guarantee absolute compliance with labor regulations, and with the marks Made in Italy and Ceramics of Italy, which certify the quality of authentic Italian style.

Per Atlas Concorde, Made in Italy non è solo un prestigioso attestato di stile, design ed eccellenza produttiva, ma un modo di essere che coinvolge tutti gli aspetti della propria attività. Per questo ci riconosciamo nei valori espressi dal codice etico di Confindustria Ceramica, che garantiscono il rispetto assoluto delle normative sul lavoro, e nei marchi Made in Italy e Ceramics of Italy, che certificano la qualità dell'autentico stile italiano.

Certifications

Company certifications / Certificazioni aziendali



Product declarations / Dichiarazioni di prodotto



Certifications for export to international markets*



Product certifications / Certificazioni di prodotto



Certification for buildings / Rating dell'edificio

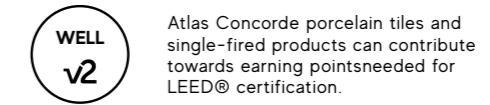

Ratings and memberships



* Shipments can be made in accordance with national requirements anywhere in the world, even in markets with complex customs procedures such as Egypt, Morocco and Kurdistan, thanks to our active cooperation with accredited certification bodies in each country. - Possibilità di spedizioni conformi alle prescrizioni nazionali ovunque nel mondo, anche in mercati con procedure doganali complesse come Egitto, Marocco, Kurdistan, grazie alla collaborazione sempre attiva con gli enti di certificazione accreditati in ciascun paese. - Dank unserer aktiven Zusammenarbeit mit den akkreditierten Zertifizierungsstellen in den einzelnen Ländern können die Sendungen in Übereinstimmung mit den nationalen Anforderungen überall auf der Welt versandt werden, selbst auf Märkten mit komplexen Zollverfahren wie Ägypten, Marokko und Kurdistan. - Possibilité d'expéditions conformes aux prescriptions nationales partout dans le monde, même sur les marchés dont les procédures douanières sont complexes comme l'Égypte, le Maroc ou le Kurdistan, grâce à la collaboration toujours active avec les organismes de certification homologués dans chaque pays. - Se pueden realizar envíos según la normativa nacional a cualquier parte del mundo, incluso a mercados con procedimientos aduaneros complejos como Egipto, Marruecos o Kurdistan, gracias a la cooperación permanente con los organismos de certificación acreditados en cada país. - Компания имеет возможность осуществлять поставки в любую точку мира в соответствии с национальными требованиями, даже на рынках со сложными таможенными процедурами, таких как Египет, Марокко, Курдистан, благодаря неизменно активному сотрудничеству с аккредитованными органами сертификации в каждой стране.

⁽¹⁾ Classificazione UPEC aggiornata al - Classement UPEC mis à jour au: 2024

⁽²⁾ Si consiglia la consultazione della pagina - On vous conseille de vous connecter à: <https://database.cstb.fr/holderdetails?UId=ETB-2094&AppRef=QB32>

⁽³⁾ Per ulteriori informazioni scrivere a - Pour tous renseignements complémentaires merci d'écrire à: france@atlasconcorde.it

⁽⁴⁾ Tutti i prodotti Atlas Concorde in gres porcellanato e in monocottura in pasta bianca possono essere utilizzati per progetti edili che seguono le linee guida del GREEN BUILDING COUNCIL e possono contribuire all'ottenimento del rating LEED V4 degli edifici.

All Atlas Concorde porcelain tiles and white-body single-fired products can be used for building projects that follow the guidelines of the GREEN BUILDING COUNCIL and can contribute to the achievement of the LEED V4 rating for buildings.





atlasconcorde.com

Copyright 2025 by Ceramiche Atlas Concorde S.p.A
(41042 Spezzano di Fiorano (MO) - Italia)
September 2025